

**SALE**



**TESA**  
TECHNOLOGY

**Mitutoyo**

**Kroeplin**  
Längenmesstechnik

**Käfer**

*Filetta*

precision measuring instruments  
mechanical - optical - electronical

Phasing out models

**While stocks last**

Revision date: February 2023



**SALE**



**TESA Valueline IP67**

Digital TESA VALUELINE calipers, affordable alternative with full TESA quality assurance.

- Measuring range: 0 - 200 mm.
- Resolution: 0.01 mm.
- Protection: IP67.

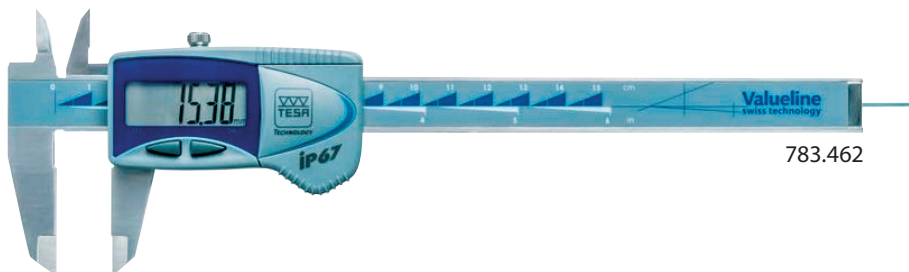

783.462

Item. No.	Measuring range/mm	Depth rod	Thumb wheel	Price EUR	-25%
783.462	0 - 150	round	-	<del>148.00</del>	<i>Sold out</i>
783.460	0 - 200	flat	✓	<del>148.00</del>	111.00

**TESA Shop-Cal digital capa μ calipers**

Digital TESA calipers with the patented *capa μ* measuring system. Original design and an excellent price-performance ratio.

- Measuring range: 0 - 200 mm.
- Resolution: 0.01 mm.
- mm/inch conversion.
- ABS/INC switchable.
- Automatic switch-off.
- Reset.
- Round depth rod: ø 1.5 mm.
- Protection: IP40.
- DIN 862.
- Power supply: 1 battery type CR2032.

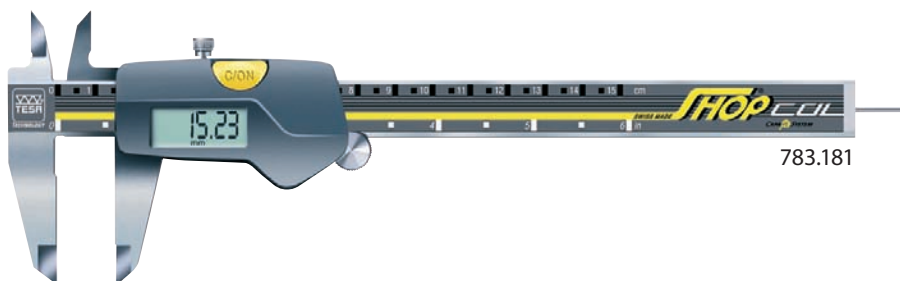

783.181

Item. No.	Measuring range/mm	Jaw length mm	Price EUR	-25%
783.181	0 - 150	40	<del>141.00</del>	<i>Sold out</i>
783.182	0 - 200	50	<del>141.00</del>	105.75

**TESA DIGIT-CAL caliper**

The advantage of these calipers is the one-time setting of the absolute zero position until the battery has to be changed.

- Measuring range: 0 - 150 mm.
- Resolution: 0.01 mm.
- Accuracy: ±0.03 mm.
- mm/inch conversion.
- Automatic switch-off.
- Protection: IP40.
- DIN 862.
- Power supply: 1 battery type 2032.
- Battery life: approx. 2 years (2000 working hours/year).

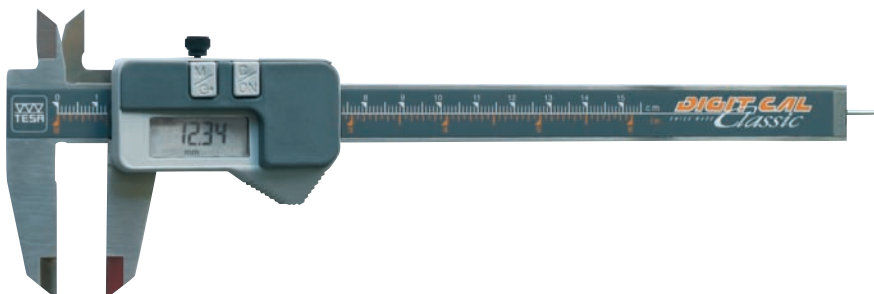

Item. No.	Price EUR	-50%
781.827	<del>141.00</del>	46.90

**SALE**



**TESA-Cal digital magna  $\mu$  calipers IP67**

High-quality series TESA calipers with the patented magna  $\mu$  measuring system, immune against magnetic fields. Highly reliable in workshop conditions; the IP67 protection degree guarantees that the calipers are resistant to dust, metal particles and oil, and even last temporary immersion. Authentic Swiss made product.

- Measuring range: 0 - 300 mm.
- Resolution: 0.01 mm.
- mm/inch conversion.
- With Opto-RS232C data output.
- Automatic switch-off.
- Reset.
- Max. measuring speed: approx. 2 m/s.
- Round ( $\varnothing$  1.5 mm) or flat depth rod.
- Protection: IP67.
- DIN 862.
- Power supply: 1 battery type CR2032.

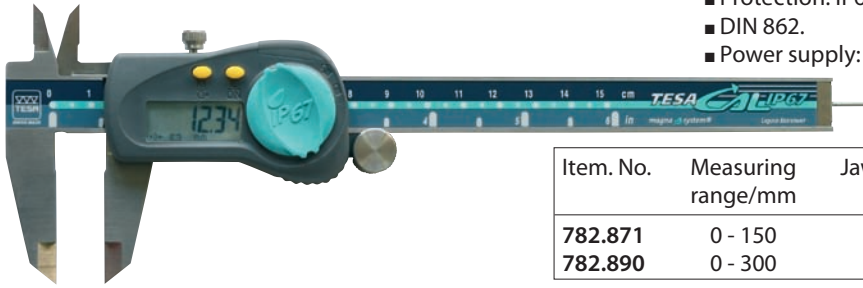

Item. No.	Measuring range/mm	Jaw length mm	Depth rod	Price EUR	-30%
782.871	0 - 150	40	round	<del>231.00</del>	75.60
782.890	0 - 300	64	flat	<del>422.00</del>	159.20

**TESA digital workshop calipers IP67**

Waterproof and dust proof calipers with measuring ranges up to 250mm. Hardened stainless steel measuring jaws, with rounded jaw ends for external measurements. Available with or without measuring knives for external measurements.

- Measuring range: 0 - 250 mm.
- Resolution: 0.01 mm.
- mm/inch conversion.
- Opto-RS232C data output, bidirectional.
- On/reset switch.
- Automatic switch-off.
- Hold function.
- Max. measuring speed: 1.8 m/s.
- Protection: IP67.
- DIN 862.
- Power supply: 1 battery type CR2032.



Item. No.	Measuring range/mm	Length/mm			Price EUR	-25%
		A	B	C		
<b>Without measuring knives (I):</b>						
782.901	0-250	5	80	-	<del>386.00</del>	264.00
<b>With measuring knives for external measurements (II):</b>						
782.908	0-200	5	80	30	<del>423.00</del>	260.00

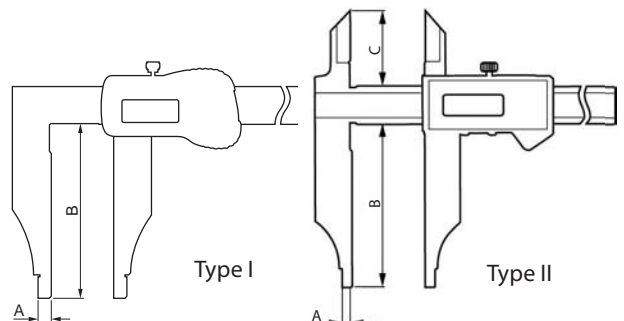



**SALE**



### Etalon digital workshop calipers

Calipers with measuring ranges up to 1000 mm. Hardened stainless steel measuring jaws, with rounded jaw ends for internal and external measurements.

- Measuring range: 0- 1000 mm.
- Resolution: 0.01 mm.
- mm/inch conversion.
- Opto-RS232C data output, bidirectional.
- Reset.
- Hold function.
- Max. measuring speed: 1.5 m/s.
- DIN 862.
- Power supply: 1 battery (CR2032).

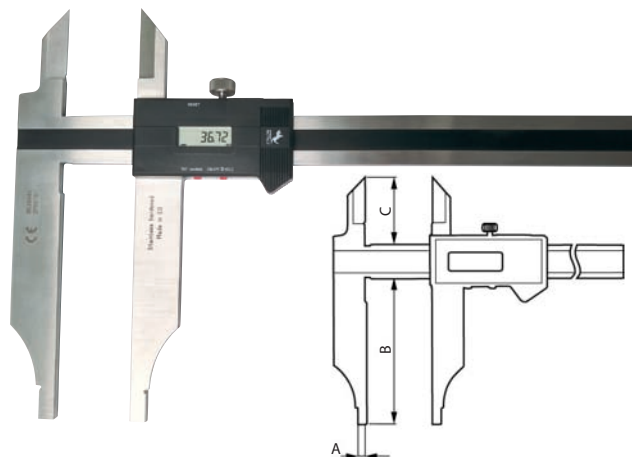

Item. No.	Length/mm			Price EUR	-25%
	A	B	C		
<b>782.254</b>	10	150	65	<del>1,586.00</del>	793.00

### TESA dial caliper

CCMA-P type stainless steel dial caliper. Can be used in rough working conditions thanks to the highly protective rack cover.

- Measuring range: 0 - 200 mm.
- Graduation: 0.02 mm, 1 revolution = 2 mm.
- Rotatable dial.
- DIN 862.
- Plastic dial housing.



Item. No.	Price EUR	-25%
<b>781.586</b>	<del>163.00</del>	114.10

### TESA dial calipers

Rugged dial calipers model CCMA-P, out of hardened stainless steel and with patented shockproof design. Ideal for use in the workshop.

- Measuring range: 0 - 150 mm.
- Graduation: 0.02 mm, 1 revolution = 2 mm.
- Rotatable dial, ø 32 mm.
- Shockproof.
- DIN 862.
- Plastic dial housing.

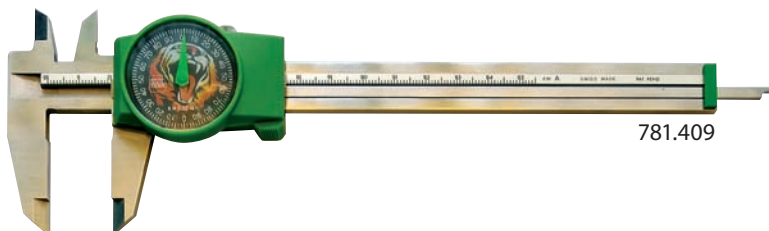

Item. No.	Price EUR	-25%
<b>781.409</b>	<del>77.00</del>	53.90
<b>781.410</b>	<del>77.00</del>	53.90
<b>781.414</b>	<del>77.00</del>	53.90
<b>781.415</b>	<del>77.00</del>	53.90



**SALE**



**Etalon & TESA vernier calipers with large measuring range**

Heavy duty stainless steel calipers with no-glare chrome finished scale and vernier.

- Measuring range: 0 - 600 mm.
- Vernier graduation: 0.02 mm or 1/1000 inch.
- DIN 862.
- Rounded jaw ends for internal measurements.
- Fine adjustment.

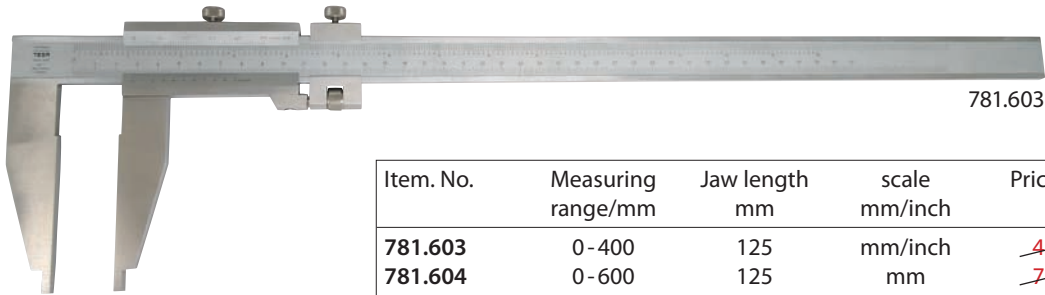

Item. No.	Measuring range/mm	Jaw length mm	scale mm/inch	Price EUR	-30%
781.603	0 - 400	125	mm/inch	<del>425.00</del>	297.50
781.604	0 - 600	125	mm	<del>765.00</del>	328.30
779.291	0 - 600	100	mm	<del>1,150.00</del>	805.00

**Etalon vernier caliper for internal measurements**

- Measuring range: 35 - 300 mm.
- Vernier: 0.05 mm.
- Stainless steel with no-glare chrome finished scale.

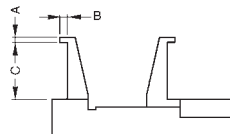
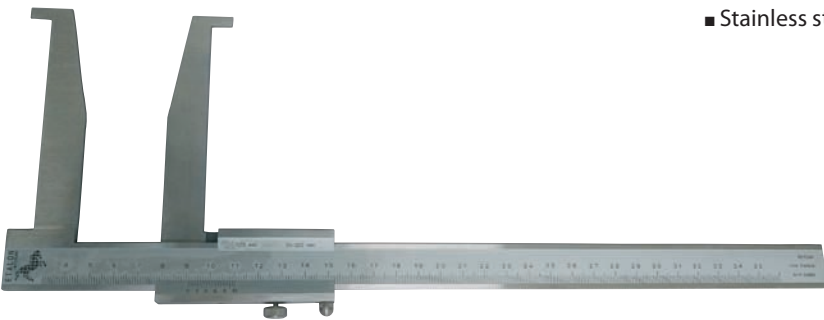

Item. No.	Size mm			Price EUR	-25%
	A	B	C		
781.767	5	10	100	<del>347.00</del>	260.25

**Etalon depth gauge**

- Measuring range: 0 - 500 mm.
- Vernier: 0.02 mm.
- Made of stainless steel, beam and slider with hardened measuring faces.
- No-glare chrome finished scale and vernier.

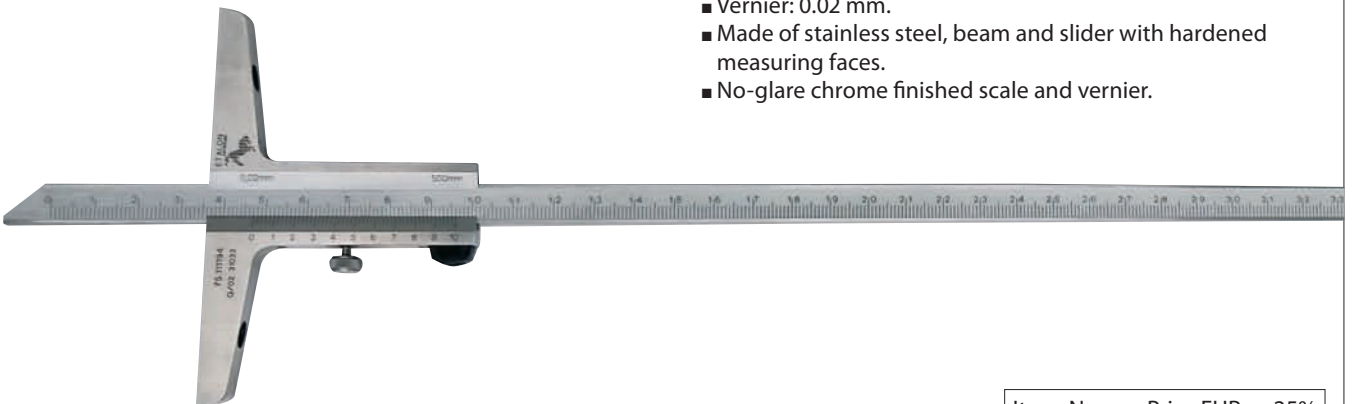

Item. No.	Price EUR	-25%
782.261	<del>293.00</del>	146.50





**SALE**



**Eталon depth gauge with removable bridge**



- Measuring range: 0-250 mm.
- Vernier: 0.02 mm.
- Made of stainless steel.
- No-glare chrome finished scale and vernier.
- Removable bridge: 250 mm

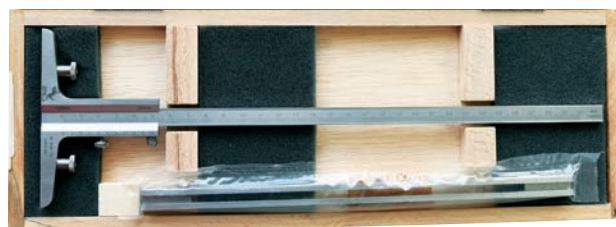

Item. No.	Price EUR	-25%
781.749	<del>354.00</del>	265.50

**TESA depth calipers**

Hardened stainless steel depth calipers with no-glare chrome finished scale and vernier. Reduced scale section for easy access to difficult measuring points. The main scale is slightly set back for wear protection. Suited for use with removable bridges. Authentic Swiss made product.

- Measuring range: 0-700 mm.
- Vernier: 0.02 or 0.05 mm.
- DIN 862.

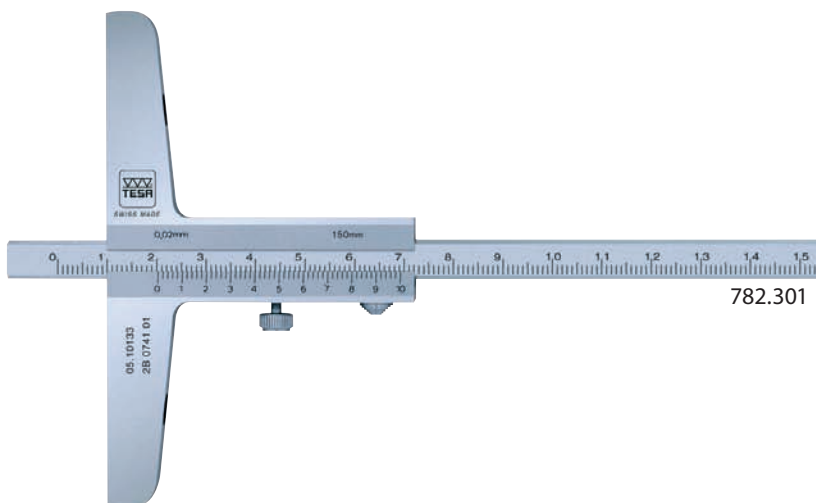

Item. No.	Measuring range/mm	Base length A/mm	Dimensions/mm					Price EUR	-25%
			B	C	D	E			
<b>Flat measuring face (I):</b>									
782.301	0-250	100	7.5	3	8	-		<i>Sold out</i>	
<b>Convertible model with a steel tip and a short cut measuring face (II):</b>									
782.305	0-250	100	7.5	3	8	4	<del>105.00</del>	105.00	
<b>Model with fine adjustment:</b>									
779.317	0-700	150	-	4	7	-	<del>1,424.00</del>	1,068.00	
<b>Models with fine adjustment (I):</b>									
779.312	0-100	80	-	4	7	-	<del>199.00</del>	149.25	
779.313	0-200	80	-	4	7	-	<del>213.00</del>	159.75	
779.315	0-400	80	-	4	7	-	<del>153.00</del>	114.75	
<b>Model with fine adjustment and steel tip:</b>									
779.321	0-200	80	-	4	7	-	<del>197.00</del>	147.75	

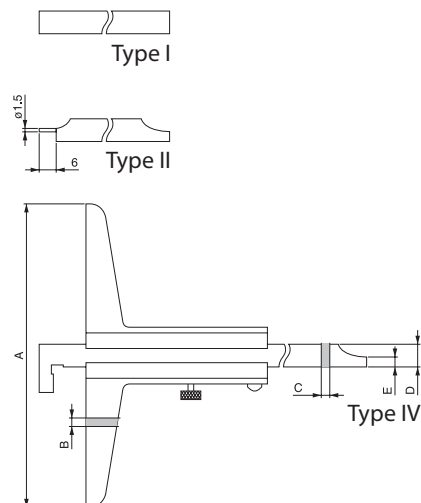

**SALE**



**Etalon gear tooth vernier calipers**

The vertical slider sets the height (H) from the top of the tooth to the pitch line. Subsequently, the horizontal slider measures the tooth thickness (G) at the pitch line.

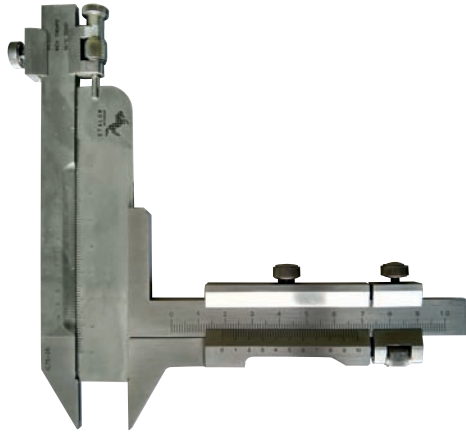

- Measuring range: Module 0.75 - 26.
- Vernier: 0.02 mm.
- Stainless steel, tungsten carbide tipped measuring faces.

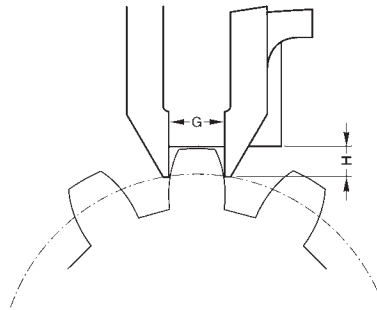

Item. No.	Price EUR	-25%
781.768	<del>1,047.00</del>	785.25

**TESA instrument set**

The most popular measuring instruments in one case, ready for daily use.

- TESA DIGIT-CAL caliper. with *capa μ* system, measuring range: 0 - 150 mm, resolution: 0.01 mm.
- Depth measuring base.
- Digital micrometer, measuring range: 0 - 30 mm, resolution: 0.001 mm.

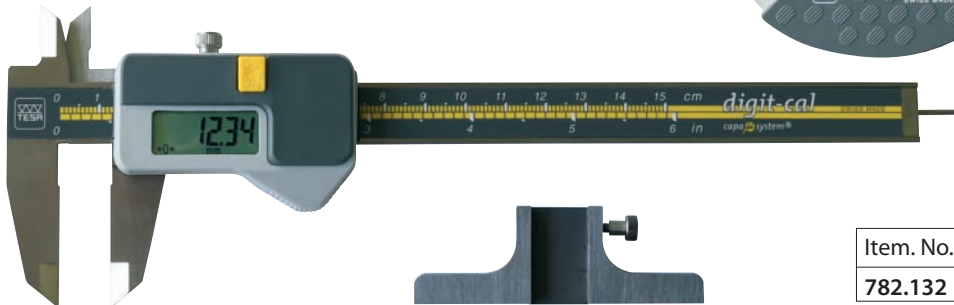

Item. No.	Type	Price EUR	-25%
782.132	DUO-SET 11	<del>358.00</del>	268.50

**TESADIGIT**

TESA micrometers are rugged mechanical precision measuring instruments for quick and highly accurate measuring of external dimensions.

- Measuring range: 0 - 100 mm.
- Resolution: 0.001 mm.
- No-glare chrome finished frame.
- Tungsten carbide measuring faces:  $\varnothing$  6.5 mm.
- Metric/inch conversion.
- Adjustable tolerance limits.
- Classification of measured values by means of LCD coloured segments: green = good, yellow = rework and red = reject.
- Hold function for measured values.

- Conforms to DIN 863/1 specifications.



781.332

Item. No.	Measuring range/mm	Price EUR	-50%
781.332	0 - 25		<i>Sold out</i>
781.333	25 - 50	<del>410.00</del>	205.00
781.334	50 - 75	<del>490.00</del>	245.00
781.335	75 - 100	<del>546.00</del>	273.00



**SALE**



**TESADIGIT with small measuring faces**

TESA micrometers are rugged mechanical precision measuring instruments for quick and highly accurate measuring of external dimensions. For measuring hard-to-reach measuring points such as grooves.

- Measuring range: 0-17 mm.



Item. No.	Price EUR	-25%
781.424	<del>361.00</del>	270.75

**TESA CLASSICMASTER**

- Measuring range: 50-75 mm.
- Graduation: 0.01 mm.
- DIN 863 T1.
- Delivery in a case with adjustment tool.



Item. No.	Price EUR	-25%
781.745	<del>154.00</del>	115.50

**TESAMASTER**

- Measuring range: 150-300 mm.
- Vernier: 0.001 mm, parallax-free.
- Accuracy: ±0.008 mm.
- Counter resolution: 0.1 mm.
- Tungsten carbide measuring faces: ø 8 mm.
- Varnished frame and chrome finished thimble.
- DIN 863 T1.
- Delivery with adjustment tool.

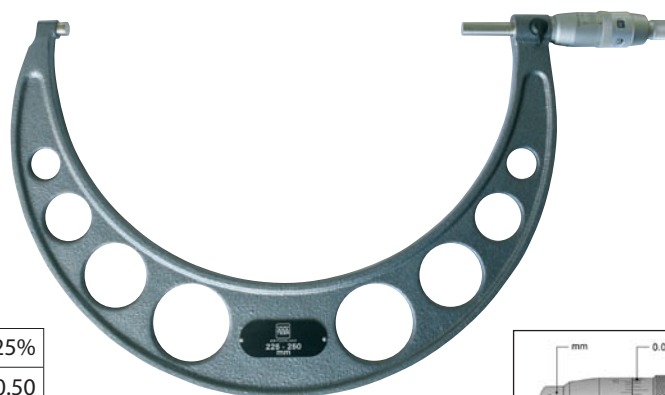

Item. No.	Measuring range/mm	Price EUR	-25%
779.011	150-175	<del>534.00</del>	400.50
779.215	225-250	<del>728.00</del>	546.00
779.015	250-275	<del>682.00</del>	511.50
779.217	275-300	<del>647.00</del>	485.25

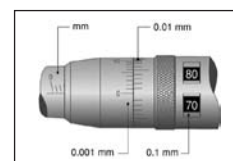



# SALE



### TESA wire and ball micrometer

- Measuring range: 0 - 10 mm.
- Graduation: 0.01 mm.
- Accuracy:  $\pm 0.004$  mm.
- No-glare chrome finished frame and thimble.
- 2 flat surfaces for supporting the wires.
- DIN 863 T3.



Item. No.	Price EUR	-25%
779.101	<del>310.00</del>	232.50

### TESA micrometer with prismatic anvil

TESA Isomaster with prismatic anvil for measuring objects with an uneven number of grooves and determining roundness errors on cylindrical surfaces. The angle of the prism aperture is designed for workpieces having a number of 7 flutes.

- Measuring range: 5 - 25 mm.
- Graduation: 0.01 mm.
- Accuracy:  $\pm 0.004$  mm.
- For 7-fluted objects, 128° V-angle.
- DIN 863 T3.

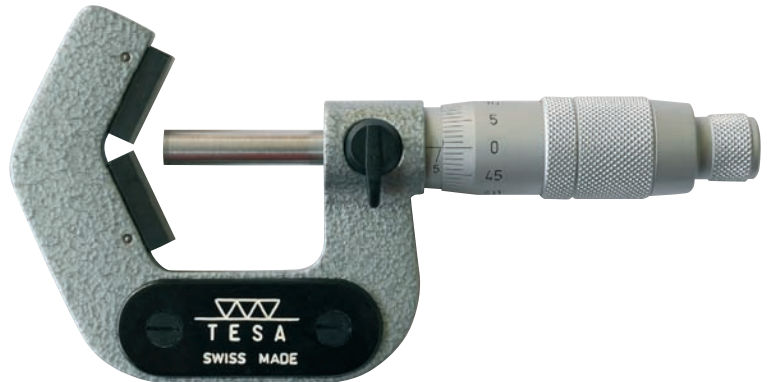

Item. No.	Price EUR	-25%
779.248	<del>375.00</del>	281.25

### TESA IMICRO SM

The IMICRO SM combines the unique measuring cone of the IMICRO with an electronic measuring system.

- Measuring range:  $\varnothing$  8 - 100 mm.
- Resolution: 0.001 mm.
- $\varnothing$  17 - 100 mm: measuring faces with extremely high wear resistant coating.

#### Measuring heads

Item. No.	Measuring range/mm	Price EUR	-25%
781.368	$\varnothing$ 8 - 10	<del>282.00</del>	211.50
781.369	$\varnothing$ 10 - 12	<del>284.00</del>	213.00
781.372	$\varnothing$ 17 - 20	<del>335.00</del>	251.25
781.374	$\varnothing$ 25 - 30	<del>379.00</del>	284.25
781.375	$\varnothing$ 30 - 35	<del>384.00</del>	288.00
781.376	$\varnothing$ 35 - 40	<del>390.00</del>	292.50
781.378	$\varnothing$ 50 - 60	<del>540.00</del>	405.00
781.382	$\varnothing$ 90 - 100	<del>573.00</del>	429.75

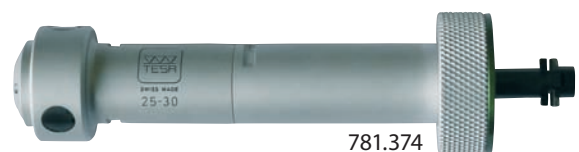

781.374



**SALE**



### TESA QUICK-CONTROL 350 C2

This versatile shop tool allows 2-point measurement of part series using one mobile insert coupled with the sensor plus another fixed one fitted with a clamp for mounting a dial gauge, precision indicator or axial probe having a 8 mm dia. clamping shaft.

- Measuring range:
    - external dia. 0 - 350 mm,
    - internal dia. 47 - 430 mm.
  - Adjustable measuring force: 0 - 15 N.
  - Reversible measurement direction.
  - Measuring repeatability:  $\pm 2 \mu\text{m}$  (excl. dial indicator and when using standard inserts).
  - The large number of bolt holes ensure many mounting possibilities.
  - Read out by means of a dial indicator, digital indicator or probe (to be ordered separately) with 8 mm dia. stem.
  - Solid base with hardened and ground steel supporting table.
- Complete set for TESA QUICK-CONTROL 350 C2
    - 1 Pair of short standard inserts,  $\varnothing 23 \text{ mm}$ .
    - 1 Pair of long standard inserts,  $\varnothing 23 \text{ mm}$ .
    - 1 Fixed insert holder with a 12 mm clamping bore,  $L = 60 \text{ mm}$ .
    - 1 Fixed insert holder with a 12 mm clamping bore,  $L = 200 \text{ mm}$ .
    - 1 Pair of short inserts  $\varnothing 30 \text{ mm}$ .
    - 1 Pair of long inserts  $\varnothing 30 \text{ mm}$ .
    - 1 Pair of adapters, shaft  $\varnothing 5 \text{ mm}$ .

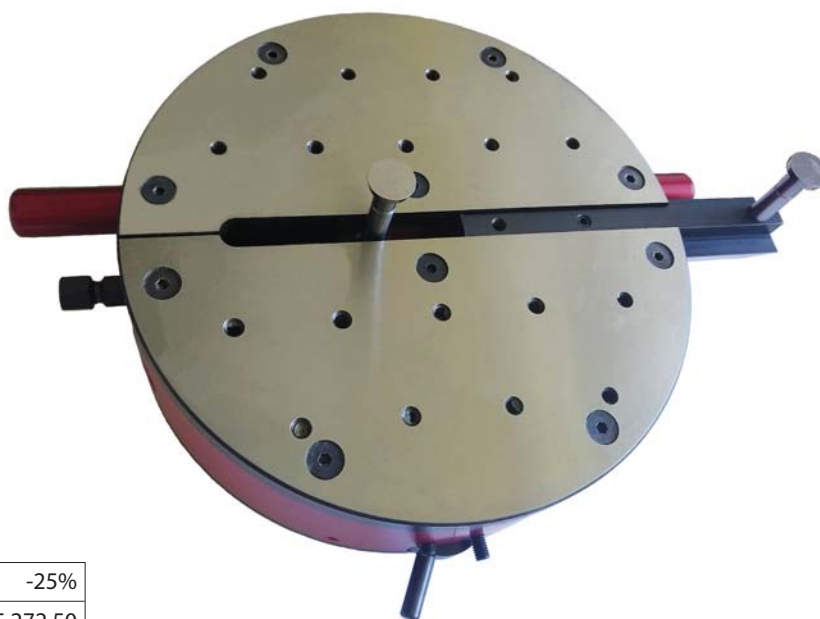

Item. No.	Price EUR	-25%
781.420	<del>7,030.00</del>	5,272.50

### Etalon micrometer head

Etalon micrometer heads serve as built-in components on measuring systems, microscopes and other measuring instruments.

- Measuring range: 0 - 25 mm.
- Vernier: 0.002 mm.
- Accuracy:  $\pm 0.003 \text{ mm}$ .
- Clamping stem:  $\varnothing 10\text{h6}$ .
- Spindle:  $\varnothing 6.5 \text{ mm}$ .
- Tungsten carbide measuring face.
- Locking screw.
- DIN 863 T2.

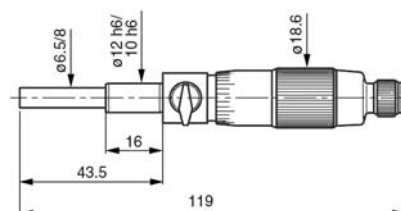

Item. No.	Price EUR	-25%
781.584	<del>224.00</del>	168.00

# SALE



## Digital dial indicators TESA Digico

Digital dial indicators with digital and digital-analog read-out. Authentic Swiss made product.

- Measuring range: 0 - 25 mm.
- Resolution: 0.01 or 0.001 mm.
- mm/inch conversion (except 783.081).
- USB/RS232C data output.
- Automatic switch-off.
- Absolute mode (spindle position is also read after automatic switch-off).
- Reset.
- Measuring force:  $\leq 2.0$  N.
- Dial diameter: 57 mm.
- Reversible measuring direction.
- Adjustable tolerance markers.
- Key lock function.
- DIN 878.
- Power supply: 1 battery type CR2032.

### TESA Digico 400/500

The 270° rotatable display guarantees an ideal read-out in any position.

- Preset.
- Overall reset.
- ABS/INC switchable.
- Numerical tolerance limits.
- Function for dynamic measurements (min, max, max-min).



Item. No.	Type	Measuring range/mm	Resolution mm	Accuracy mm	Price EUR	-25%
<b>TESA Digico 200/300:</b>						
783.081	305 M	0 - 12.5	0.001	$\pm 0.008$	<del>328.00</del>	246.00
<b>TESA Digico 400/500:</b>						
781.708	405 MI	0 - 12.5	0.01	$\pm 0.02$	<del>388.00</del>	291.00
783.143	510 MI	0 - 25	0.001	$\pm 0.005$		<i>Sold out</i>



**SALE**

## Mitutoyo

### Mitutoyo dial calipers

Mitutoyo dial calipers, made of special corrosion-free steel, with hardened and lapped measuring faces and protected rack. The slider is titanium coated.

- Measuring range: 0 - 300 mm.
- Graduation: 0.02 mm.
- Titanium coating is applied to the sliding surfaces (except for 0 - 300 mm model).

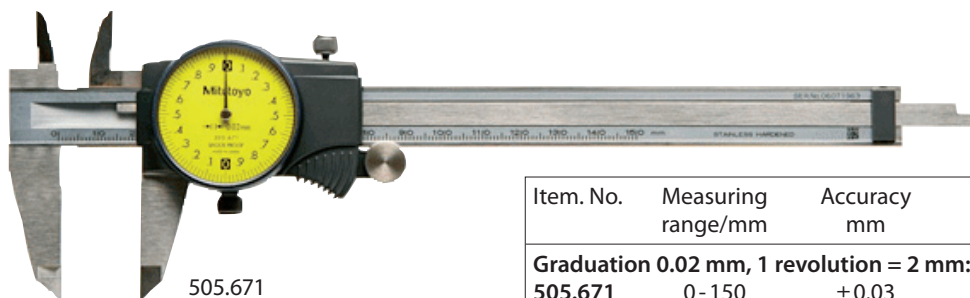

Item. No.	Measuring range/mm	Accuracy mm	Price EUR	-25%
<b>Graduation 0.02 mm, 1 revolution = 2 mm:</b>				
505.671	0 - 150	±0.03	<del>95.00</del>	71.25
505.672	0 - 200	±0.03	<del>195.00</del>	195.00
505.673	0 - 300	±0.04	<del>294.00</del>	294.00

### Mitutoyo Absolute Digimatic depth gauge

Specially designed to measure tire tread depth.

- Measuring range: 0 - 25 mm.
- Resolution: 0.01 mm.
- Accuracy: ±0.02 mm.
- Digimatic data output.



Item. No.	Price EUR	-25%
571.100	<del>208.00</del>	156.00

### Mitutoyo Borematic three-point internal micrometer

Three-point internal micrometer with the Absolute system and a large 6 digit LCD display for an easy read-out of the measurement and tolerance indication. The 330° rotatable display guarantees an ideal read-out in any position. Easy and fast one-handed operation.

- Measuring range: 16 - 20 mm.
- Resolution: 0.001 mm.
- Accuracy: ±0.005 mm. Only valid with close contact of all measuring surfaces.
- ABS/INC switchable.
- Digimatic data output.
- Dial rotatable over 330°.
- Adjustable tolerance limits.
- Lapped tungsten carbide measuring faces.
- Power supply: 1 battery (V357).



Item. No.	Price EUR	-25%
568.335	<del>1,070.00</del>	802.50

SALE

Mitutoyo

## Mitutoyo external measuring instrument

- Measuring range: 0 - 10 mm.
- Graduation: 0.01 mm.
- Accuracy:  $\pm 0.02$  mm.
- Measuring force:  $\leq 1.3$  N.

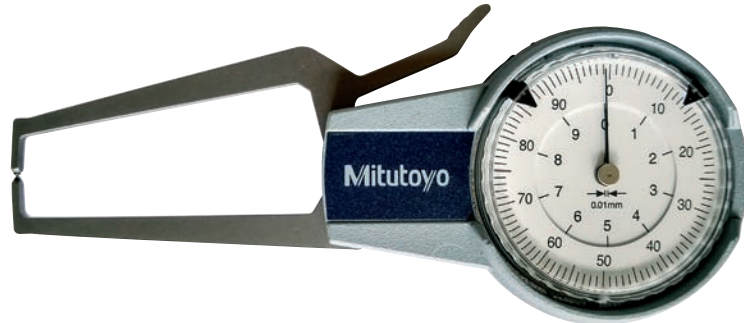

Item. No.	Price EUR	-25%
209.659	<del>401.50</del>	301.13

## Mitutoyo internal measuring instrument

Mitutoyo offers a complete selection of Bore Gages, all of them with interchangeable anvils and necessary accessories to perform close tolerance ID measurements

- Measuring range: 18 - 35 mm.
- Graduation: 0.001 mm.
- Most popular Bore Gages.
- Carbide-tipped contact points for durability.
- The dial indicator is fully protected by a rugged cover.
- Optional extension rods can be attached for measuring deep holes.
- Economy Bore Gage Sets are also available.



Item. No.	Price EUR	-25%
511.167	<del>298.30</del>	223.73

## Mitutoyo dial indicator 0.01 mm

A multi-revolution dial indicator suited to general measurement applications. The dual-reading scale aids measurements in both directions.

- Measuring range: 0 - 10 mm.
- Graduation: 0.01 mm.
- Accuracy:  $\pm 0.013$  mm.
- Measuring force:  $\leq 1.4$  N.
- 1 pointer revolution = 1 mm.
- Scale numbering: 0 - 100 (100 - 0).
- Clamping stem:  $\varnothing 8$  mm.
- Rotatable dial with locking screw and adjustable tolerance markers.
- Back with lug.



Item. No.	Price EUR	-25%
204.610	<del>64.00</del>	49.50





**SALE**

# Mitutoyo

## Mitutoyo lever-type dial test indicator 0.01 mm

This dial test indicator is able to measure in both directions without having to switch direction.

- Measuring range: 0.8 mm.
- Graduation: 0.01 mm.
- Accuracy:  $\pm 0.008 f_{ges}/mm$ .
- Measuring force:  $\leq 0.3 N$ .
- Scale numbering: 0-40-0.
- Clamping stem:  $\varnothing 8 mm$ .



Item. No	Price EUR	-25%
513.284	<del>113.00</del>	84.75

## Mitutoyo stand magnifier

A simple, all-purpose magnifier.



Item. No	Description	Price EUR	-25%
183.301	7x magnification	<del>25.00</del>	18.75
183.302	10x magnification	<del>29.00</del>	21.75

## Mitutoyo ring light

The ring light provides you with additional, intensive, fluorescent illumination.

In addition:

- This type of light source prevents colour errors in the image caused by the colour characteristics of the illumination.
- The ring-shaped positioning of the light source around the objective ensures even illumination of the subject without interfering shadows.

- Connection  $\varnothing 50 mm$
- Delivery with power supply and extra spare bulb.



Item. No.	Price EUR	-25%
377.090	<del>220.00</del>	165.00

**SALE**

**Kroepelin**  
Längenmesstechnik

**Kroepelin internal measuring instrument H2X001 IP65**

- Measuring range: 10 - 30 mm.
- Graduation: 0.01 mm.
- Protection: IP65.
- Including depth measuring gauge.



Item. No.	Price EUR	-15%
854.902	<del>647.00</del>	549.95

**Kroepelin digital internal measuring instrument IP63**

Kroepelin's quickest measuring instruments has a compact, ergonomical design. The digital-analog display makes read-out easier.

- Measuring range: 40 - 100 mm.
- Resolution: 0.02 mm.
- Accuracy:  $\pm 0.06$  mm.
- Repeatability: 0.04 mm.
- mm/inch conversion.
- ABS/INC switchable.
- With tolerance display.
- Purpose-built measuring program and measuring inserts.

- Protection: IP63.
- Power supply: 1 battery type AA.



Item. No.	Price EUR	-15%
854.895	<del>466.00</del>	396.10
<b>Options:</b>		
854.892	Digimatic interface	<del>89.00</del> 75.65
854.893	USB interface	<del>91.00</del> 77.35



854.892



854.893

**Kroepelin internal measuring instruments Intertest**

Measuring instruments for accurate and reliable measurements of internal dimensions.

- Measuring range: 15 - 310 mm.
- Very fine tolerances on the various parts.
- Impact and shock-resistant housing.
- Shock-resistant movement of the measuring arm.
- Two adjustable tolerance markers.



854.807

Item. No.	Measuring range/mm	Graduation mm	Accuracy mm	Repeatability mm	Price EUR	-15%
854.823	80 - 100	0.01	$\pm 0.03$	$\pm 0.01$	<del>322.00</del>	273.70
854.807	15 - 65	0.05	$\pm 0.05$	$\pm 0.025$	<del>377.00</del>	320.45
854.810	70 - 120	0.05	$\pm 0.05$	$\pm 0.025$	<del>435.00</del>	369.75
854.820	180 - 310	0.05	$\pm 0.075$	$\pm 0.05$	<del>570.00</del>	484.50



**SALE**

**Kroepelin**  
Längenmesstechnik

**Kroepelin external measuring instruments Oditest IP65**

External measuring instrument in a version which is highly accurate and reliable.

- Measuring range: 0 - 50 mm.
- Very fine tolerances on the various parts.
- Impact and shock-resistant housing.
- Dust and drip proof.
- Shock-resistant movement of the measuring arms.
- Two adjustable tolerance markers.
- Protection: IP65.



854.765

Item. No.	Measuring range/mm	Graduation mm	Accuracy mm	Repeatability mm	Price EUR	-15%
<b>854.765</b>	0 - 20	0.01	±0.03	±0.01	<del>312.00</del>	265.20
<b>854.775</b>	0 - 50	0.05	±0.05	±0.025	<del>377.00</del>	320.45

**Kroepelin external measuring instrument Oditest IP65**

External measuring instrument in a version which is highly accurate and reliable.

- Measuring range: 0 - 50 mm.
- Graduation: 0.1 mm.
- Accuracy: ±0.15 mm.
- Repeatability: 0.075 mm.
- Very fine tolerances on the various parts.
- Impact and shock-resistant housing.
- Dust and drip proof.
- Damped movement of the measuring arm.
- Adjustable tolerance markers.
- Protection: IP65.

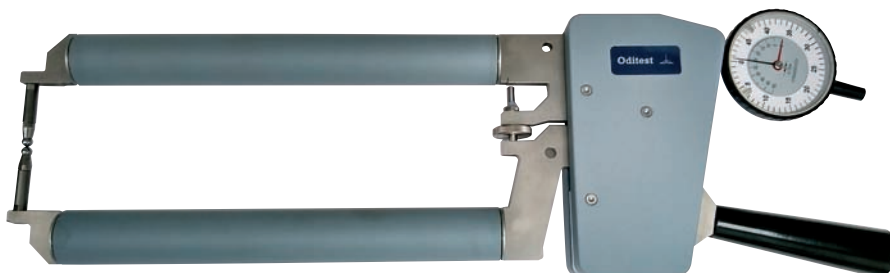

Item. No.	Price EUR	-15%
<b>854.008</b>	<del>834.00</del>	708.90

**Kroepelin external measuring instruments Oditest 22**

External measuring instrument in a version which is highly accurate and reliable.

- Measuring range: 20 - 40 mm.
- Graduation: 0.01 mm.



Item. No.	Price EUR	-15%
<b>854.063</b>	<del>284.00</del>	241.40

**SALE****Kroeplin**  
Längenmesstechnik**Kroeplin external measuring instruments Schnelltaster**

- Measuring range: 20 - 50 mm.
- Graduation: 0.1 mm.
- Insert diameter:  $\varnothing 0.75$  mm
- Insert tip length: 3 mm



Item. No.	Price EUR	-15%
854.172	<del>249.00</del>	211.65



**SALE**



**Käfer digital external measuring instrument 0.001 mm**

Fast thickness measurement of small parts and sheet and foil material.

- Measuring range: 0 - 12.5 mm.
- Resolution: 0.001 mm.
- mm/inch conversion.
- USB/RS232C data output.
- On/off switch.
- Reset/preset.
- Interchangeable measuring inserts.
- Measuring faces:  $\varnothing$  10 mm.
- Different types of inserts available.
- Power supply: 1 battery type CR2032.



Item No.	Price EUR	-15%
852.379	<del>471.00</del>	400.35



SALE



### Digital three-point internal micrometers

Digital three-point internal micrometers with a resolution of 0.001 mm for accurately measuring (blind) bores. These micrometers have several functions, and combined with the accurate read-out this results in a favourable price-performance ratio.

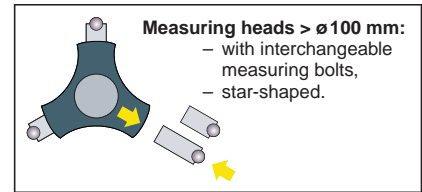

- Measuring range:  $\varnothing$  6 - 300 mm.
- Resolution: 0.001 mm.
- mm/inch conversion.
- ABS/INC switchable.
- On/off switch.
- Automatic switch-off.
- Reset/preset.
- Self-centering.
- Tungsten carbide measuring faces.
- Interchangeable measuring bolts from measuring range  $\varnothing$  100 - 125 mm.
- Protection: IP54.
- Delivery in a case, incl. extension 150 mm (measuring range  $\varnothing$  6 - 12 mm: 100 mm).
- Separate instruments within measuring range  $\varnothing$  6 - 100 mm are delivered incl. setting ring(s) (conforms to factory standard).
- Power supply: 1 battery type V357.

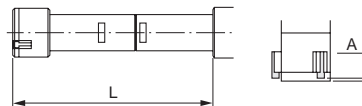

Item No.	Measuring range/mm	Setting ring $\varnothing$ /mm	Accuracy mm	Length L/mm	Length A/mm	Price EUR	-35%
906.886	$\varnothing$ 6- 8	6	$\pm 0.004$	54.5	0.7		<i>Sold out</i>
906.887	$\varnothing$ 8- 10	8	$\pm 0.004$	54.5	0.7		<i>Sold out</i>
906.888	$\varnothing$ 10- 12	10	$\pm 0.004$	54.5	0.7		<i>Sold out</i>
906.889	$\varnothing$ 12- 16	16	$\pm 0.004$	80	0.7		<i>Sold out</i>
906.890	$\varnothing$ 16- 20	16	$\pm 0.004$	80	0.7		<i>Sold out</i>
906.891	$\varnothing$ 20- 25	25	$\pm 0.004$	90	0.7	<del>274.00</del>	178.10
906.892	$\varnothing$ 25- 30	25	$\pm 0.004$	90	0.7		<i>Sold out</i>
906.893	$\varnothing$ 30- 40	40	$\pm 0.004$	97	0.7		<i>Sold out</i>
906.894	$\varnothing$ 40- 50	40	$\pm 0.005$	97	0.7		<i>Sold out</i>
906.895	$\varnothing$ 50- 63	62	$\pm 0.005$	114	0.7		<i>Sold out</i>
906.896	$\varnothing$ 62- 75	62	$\pm 0.005$	114	0.7		<i>Sold out</i>
906.897	$\varnothing$ 75- 88	87	$\pm 0.005$	114	0.7		<i>Sold out</i>
906.898	$\varnothing$ 87-100	87	$\pm 0.005$	114	0.7	<del>376.00</del>	244.40
906.899	$\varnothing$ 100-125	-	$\pm 0.005$	145	0.7		<i>Sold out</i>
908.675	$\varnothing$ 125-150	-	$\pm 0.005$	145	0.7	<del>415.00</del>	269.75
908.676	$\varnothing$ 150-175	-	$\pm 0.005$	145	0.7		<i>Sold out</i>
908.677	$\varnothing$ 175-200	-	$\pm 0.005$	145	0.7		<i>Sold out</i>
908.678	$\varnothing$ 200-225	-	$\pm 0.007$	145	0.7	<del>654.00</del>	425.10
908.679	$\varnothing$ 225-250	-	$\pm 0.007$	145	0.7		<i>Sold out</i>
908.680	$\varnothing$ 250-275	-	$\pm 0.007$	145	0.7	<del>904.00</del>	587.60
908.681	$\varnothing$ 275-300	-	$\pm 0.007$	145	0.7	<del>1,067.00</del>	693.55



**SALE**

*Filetta*

**Three-point bore micrometers**

Three-point bore micrometers, also for measuring blind bores.

- Measuring range:  $\varnothing$  6 mm -  $\varnothing$  100 mm.
- Reading: 0.005 mm.  
906.670 - 906.672 and 906.665: 0.001 mm

- The sets are delivered including setting rings.

**Sets**

Item. No.	Measuring range/mm	Price EUR	-35%
906.670	$\varnothing$ 6 - 8	<del>201.00</del>	130.65
906.671	$\varnothing$ 8 - 10	<del>201.00</del>	130.65
906.672	$\varnothing$ 10 - 12	<del>201.00</del>	130.65
906.673	$\varnothing$ 11 - 14	<i>Sold out</i>	
906.674	$\varnothing$ 14 - 17	<i>Sold out</i>	
906.675	$\varnothing$ 17 - 20	<del>169.00</del>	109.85
906.676	$\varnothing$ 20 - 25	<del>196.00</del>	127.40
906.677	$\varnothing$ 25 - 30	<del>196.00</del>	127.40
906.678	$\varnothing$ 30 - 35	<del>199.00</del>	129.35
906.679	$\varnothing$ 35 - 40	<i>Sold out</i>	
906.680	$\varnothing$ 40 - 50	<i>Sold out</i>	
906.681	$\varnothing$ 50 - 60	<del>231.00</del>	150.15
906.682	$\varnothing$ 60 - 70	<i>Sold out</i>	
906.683	$\varnothing$ 70 - 80	<del>246.00</del>	159.90
906.684	$\varnothing$ 80 - 90	<del>261.00</del>	169.65
906.685	$\varnothing$ 90 - 100	<i>Sold out</i>	

Item. No.	Measuring range/mm	Price EUR	-35%
906.665	$\varnothing$ 6 - 12	<del>564.00</del>	366.60
906.666	$\varnothing$ 11 - 20	<i>Sold out</i>	
906.667	$\varnothing$ 20 - 40	<i>Sold out</i>	
906.668	$\varnothing$ 40 - 100	<del>1,247.00</del>	810.55



906.676



906.667

**Ceramic surface plates**

Surface plates made of alumina ceramics are very durable, even under mechanically or chemically aggravating conditions. Some other important characteristics of alumina ceramics are:

- Low density.
- Low linear expansion coefficient.
- Low thermal conduction coefficient.
- High degree of hardness.
- Highly wear resistant.
- High rigidity through its unique hollow structure, as well as light in weight.
- Exceptionally strong.
- Easy to maintain.

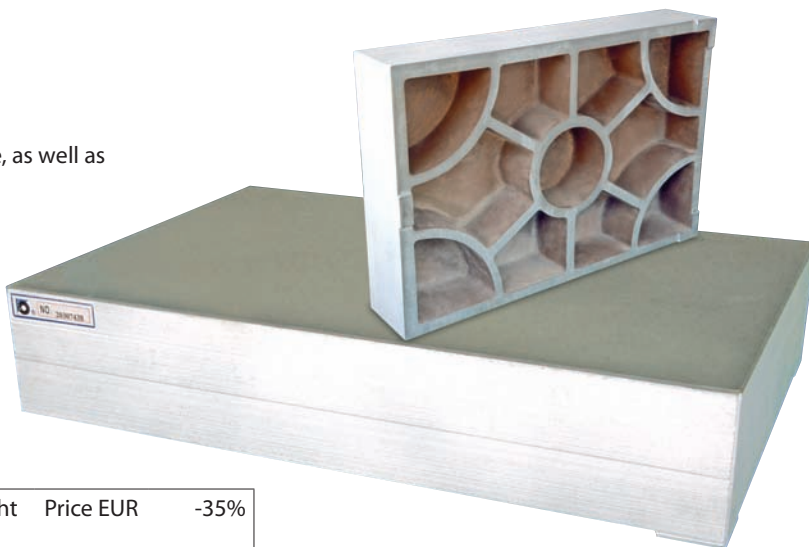

Delivery ex Groningen, Netherlands

Item No.	Flatness mm	Dimensions l x w x t / mm	Weight kg	Price EUR	-35%
<b>Class A:</b>					
908.713	0.008	600 x 450 x 90	45	<del>1,940.00</del>	1,242.00
<b>Class AAA:</b>					
908.706	0.002	450 x 300 x 90	20	<i>Sold out</i>	
908.707	0.002	600 x 450 x 90	45	<del>2,350.00</del>	1,503.00
908.708	0.003	630 x 630 x 150	90	<del>3,270.00</del>	2,090.00

# SALE

## Filetta

### Feeler stock coils

Feeler stock coils made of hardened or stainless steel.

- Measuring range: 0.01 - 1.00 mm.
- Length: 5 m.
- Width: 12.7 mm.



909.939

Thickness mm	Item. No.	Price EUR	-75%	Item. No.	Price EUR	-75%
	<b>Hardened steel:</b>			<b>Stainless steel:</b>		
0.01	909.928		<i>Sold out</i>	909.950	<del>43.00</del>	11.60
0.02	909.929	<del>27.40</del>	7.40	909.951	<del>39.90</del>	10.70
0.03	909.930	<del>21.20</del>	5.70	909.952	<del>25.90</del>	6.90
0.04	909.931		<i>Sold out</i>	909.953	<del>25.90</del>	6.90
0.05	909.932		<i>Sold out</i>	909.954	<del>25.90</del>	6.90
0.06	909.933		<i>Sold out</i>	909.955	<del>25.90</del>	6.90
0.07	909.934		<i>Sold out</i>	909.956		<i>Sold out</i>
0.08	909.935	<del>21.20</del>	5.70	909.957	<del>25.90</del>	6.90
0.09	909.936	<del>21.20</del>	5.70	909.958		<i>Sold out</i>
0.10	909.937		<i>Sold out</i>	909.959	<del>25.90</del>	6.90
0.15	909.938	<del>21.20</del>	5.70	909.960	<del>25.90</del>	6.90
0.20	909.939	<del>21.20</del>	5.70	909.961	<del>25.90</del>	6.90
0.25	909.940	<del>21.20</del>	5.70	909.962	<del>25.90</del>	6.90
0.30	909.941		<i>Sold out</i>	909.963	<del>25.90</del>	6.90
0.35	909.942	<del>21.20</del>	5.70	909.964	<del>25.90</del>	6.90
0.40	909.943	<del>21.20</del>	5.70	909.965	<del>25.90</del>	6.90
0.50	909.944	<del>21.20</del>	5.70	909.966	<del>25.90</del>	6.90
0.60	909.945	<del>21.20</del>	5.70	909.967	<del>25.90</del>	6.90
0.70	909.946	<del>21.20</del>	5.70	909.968	<del>25.90</del>	6.90
0.80	909.947	<del>21.20</del>	5.70	909.969	<del>25.90</del>	6.90
0.90	909.948	<del>21.20</del>	5.70	909.970	<del>25.90</del>	6.90
1.00	909.949	<del>21.20</del>	5.70	909.971	<del>25.90</del>	6.90

Schut Geometrical Metrology (Schut Geometrische Meettechniek bv) is an international organization, founded in 1949, with five offices throughout Europe, specialized in the development, production, sales and service of precision measuring instruments and systems.

Schut Geometrical Metrology is ISO 9001 certified. Our reliable service and excellent technical advice assist you in determining your optimal quality strategy.

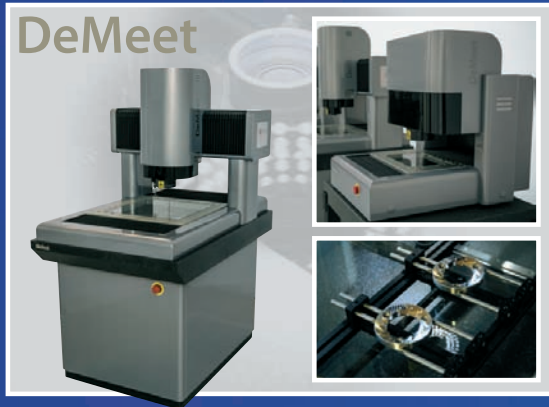

Products developed and produced by Schut Geometrical Metrology are the 3D CNC coordinate measuring machines DeMeet (video, touch probe and multi-sensor model) and product fixture systems.

Besides products of well-known producers like Magnescale (electronic scales, gauges and display units), TESA, Mitutoyo, Helios-Preisser (measuring instruments), Fisso (dial indicator stands), Käfer and Peacock (dial indicators), Witte (Alufix fixture system), Peak (magnifiers and microscopes), LMW (gauges), Schwenk and Kröplin (internal/external measuring instruments), Marposs (internal measuring instruments), Dino-Lite (digital microscopes) and Renishaw (probe systems) Schut offers an extensive range of measuring equipment in various price ranges, such as microscopes, surface plates, measuring stands, dial indicators, rulers, straight edges, squares, angle measuring instruments, micrometers and calipers.

### Schut Geometrische Meettechniek bv

Duinkerkenstraat 21  
 9723 BN Groningen  
 The Netherlands  
 Tel: +31 (0)50 5 877 877  
 E-mail: SchutNL@Schut.com

ISO 9001

SCHUT.COM

The prices and specifications mentioned in this catalog can change at any moment.  
 For current prices and information refer to our online catalog on [www.Schut.com](http://www.Schut.com).